



arlo™

Arlo Go Quick Start Guide



What's Included



Arlo Go camera

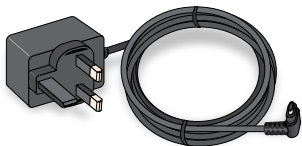

Power adapter
(varies by region)



Rechargeable
battery



Mount screws

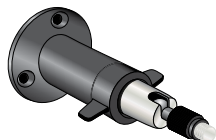

Mount

Get the Arlo App

For the best experience, download the Arlo app for your smartphone by scanning this QR code.



arlo.netgear.com



Insert the SIM Card Into Your Arlo Go Camera

The camera uses a mobile network to send pictures and videos to your Arlo account in the cloud. Before using the Arlo Go camera, you must install a SIM card.

Note: To obtain a SIM card, contact your mobile network service provider.

To use Arlo Go, make sure that the SIM card is active, that there is data in your account, and that any existing SIM PIN is deactivated or disabled.

➤ To insert a SIM card:

1. Unlock the battery compartment by pressing and holding the latch.
2. Gently pull the battery door back to open the compartment.
3. Align the gold SIM contacts.
4. Insert the SIM card into the SIM card slot.

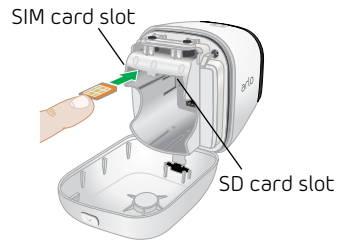

Insert the Battery Into Your Arlo Go Camera

If power is available, you can plug your camera in and use it in powered mode. We recommend that you insert the battery into your Arlo Go camera even if you plan to power the camera using the power adapter.

➤ To insert the battery:

1. Unlock the battery compartment by pressing and holding the latch.
2. Gently pull the battery door back to open the compartment.

Set Up Your Arlo Go Camera

3. If you plan to store video recordings on an SD card, insert the SD card now.

The camera comes with an SD card slot that supports SD cards (sold separately) with a capacity of up to 32 GB of storage. If you inserted an SD card and your camera is offline, the camera recordings are stored on the SD card.

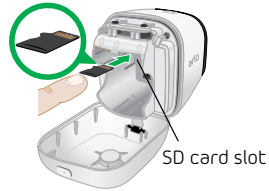

Note: You must insert the SD card before powering the camera on.

4. Align the battery contacts.
5. Insert the battery.
6. Close the battery door.



Use the Arlo app and your Arlo account to set up your Arlo Go camera. If you already set up an Arlo account, you can add the Arlo Go camera to your account.

During setup, your Arlo Go camera must be connected to the mobile network.

Note: This requires that you are using a compatible device and that you subscribe to a mobile service plan.

After you add your Arlo Go camera to your Arlo account, you can place the Arlo Go camera anywhere in your mobile network coverage area.

For information about optimizing mobile connectivity, scan this QR code or visit <http://tinyurl.com/jyoysqo>.



➤ **To create a new Arlo account:**

1. Launch the Arlo app from your smartphone, tap **New to Arlo?** and select **Arlo Go**.

If you are using a computer, visit arlo.netgear.com.

Note: If you see a message indicating that your mobile connection is not active, you might need to edit the APN. For information about viewing and editing APNs, refer to the Arlo Go user manual.

2. Follow the onscreen instructions.

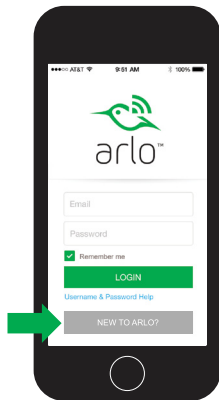

➤ **To add an Arlo Go camera to an existing Arlo account:**

1. If you already set up an Arlo account, log in, and click or tap **Add Device**.
2. Follow the onscreen instructions.

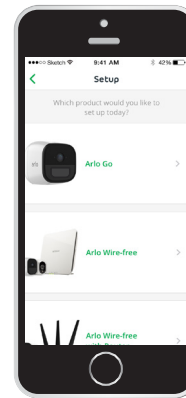
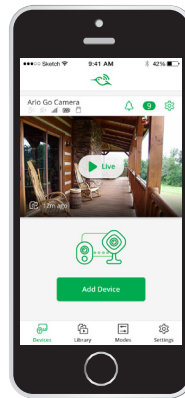

Place Your Camera

You can place your camera on a flat surface or mount it.

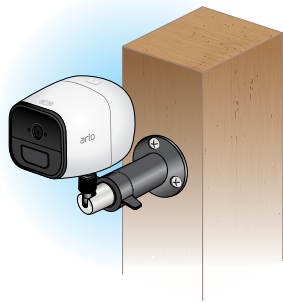
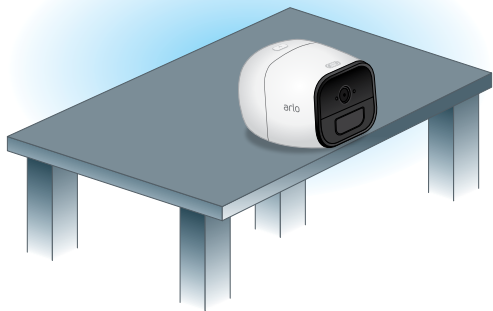

➤ To mount the camera on a wall:

1. Place the wall plate and secure it with three screws.

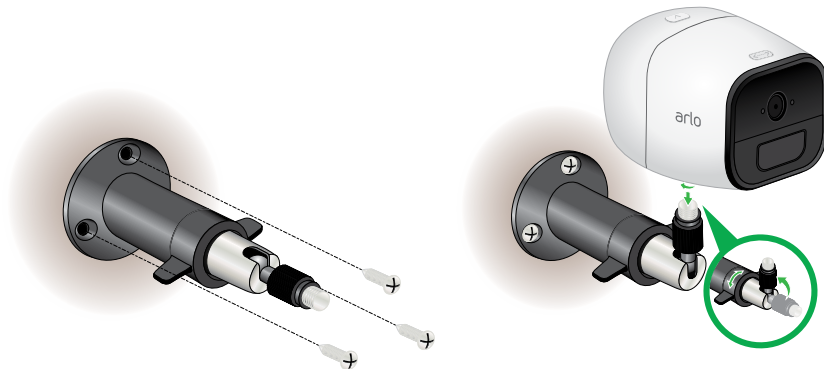

2. Attach the camera to the wall plate.
If you're mounting the camera to drywall, be sure to use the included plastic drywall anchors.

Charge Your Arlo Go Battery

The Arlo Go battery is partially charged when it leaves the factory.

➤ To recharge the battery:

1. Connect the power adapter to the camera.

Caution: You must use an Arlo Go power adapter to charge the battery. Do not try to power the camera or charge the battery with any power adapter other than the one provided with the Arlo Go camera.

2. Plug the power adapter into an electrical outlet.



The camera LED lights solid blue for two seconds when the camera battery is fully charged.

Arlo Go Access and Cloud Storage

The Arlo Go camera is designed to connect to a mobile network.

Connecting to the camera through the cloud requires that you are using a compatible device and that your Internet connection is active. Coverage and service are not available everywhere.

During setup, the Arlo app uses the mobile network to find your Arlo Go camera so that you can add the camera to your Arlo account.

After setup, the Arlo Go camera uses the mobile network to send recordings to the cloud storage associated with your Arlo account.

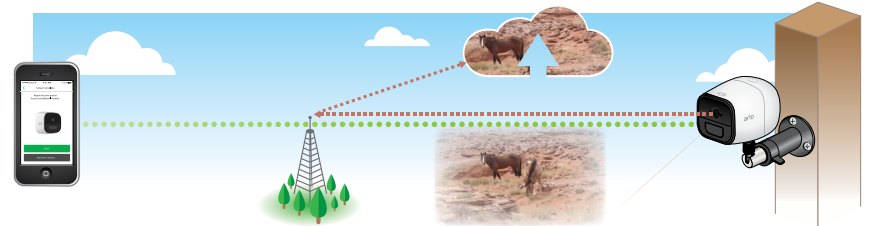

You're Done!

Congratulations! Your Arlo Go camera is set up and ready to go.

To view useful tutorial videos, find troubleshooting tips, or get support, visit support.arlo.com.

Camera LED Guide



● **Solid amber**
No SIM card is inserted or the SIM card is damaged.

☀ **Very slow blinking blue**
The camera is powering on.

☀ **Slow blinking amber**
Mobile network coverage is not available.

☀ **Fast blinking amber**
The camera connected to the cellular network but it cannot connect to the cloud.

☀ **Slow blinking blue**
The camera is ready to scan the QR code.

☀ **Blinking amber and purple**
The SD card type is invalid.

For more information, visit <http://tinyurl.com/h8csb5a> or scan this QR code:

☀ **Fast blinking blue**
The camera is connected to the cloud.

☀ **Blinking amber and blue**
The camera is receiving a firmware upgrade.



☀ **Blinking blue and purple**
The camera is connecting to the network and the cloud.

©NETGEAR, Inc., NETGEAR, the NETGEAR Logo, and Arlo are trademarks of NETGEAR, Inc.

Compliance

For the current EU Declaration of Conformity, visit
http://kb.netgear.com/app/answers/detail/a_id/11621/.

For regulatory compliance information, visit
<http://www.netgear.com/about/regulatory/>.

NETGEAR®

350 East Plumeria Drive
San Jose, CA 95134 USA



NETGEAR INTL LTD

Building 3, University Technology Center
Curraheen Road, Cork, Ireland



201-21725-02

April 2017

